

# User manual

English | Nederlands | Deutsch | Français | Español | Português | Italiano | 繁體中文 | 简体中文 | 日本語

# 2850 Banknote Counter



# Introduction

---

Thank you for purchasing a Safescan 2850 banknote counter. For proper use and maintenance we advise you to read this user manual carefully.

## Please note

---

Should the equipment be altered in any way or used in a manner for which it was not intended at the time of delivery, the supplier of the equipment accepts no responsibility for injury or damage to personnel or equipment. If the conditions for use of the equipment are changed, the supplier must be contacted or the declaration of conformity will be invalidated.

## Safety instructions

---

- Place the machine on a flat and stable surface.
- Do not place the machine in dusty or dirty environments.
- Use the supplied dust cover when the machine is not in use.
- Do not place the machine in direct sunlight or near heat sources or air conditioners.
- Always connect the device to a grounded power outlet.
- Use only the supplied power cord.
- Operation temperature 15-35 °C / 59-95 °F.
- Operation humidity 30-80% R.H.
- Do not use the machine outdoors.
- Do not expose the machine to liquids.
- This machine contains rotating parts. Never touch the moving parts when the machine is switched ON.
- Please ensure that no foreign objects (coins, paper clips, staples,) fall into the machine, these may block the mechanical parts and the sensors of the machine and damage or break them and will void your warranty.
- Keep jewellery, long hair, ties and other protruding parts away while operating the machine.
- Never disassemble the machine.
- To prevent shock hazard, do not touch the power cable with wet hands.
- Unplug the device if you want to move it to another position.
- Hold the plug when disconnecting the unit from the power outlet, never pull the cord.

## Product overview and box contents

### Front

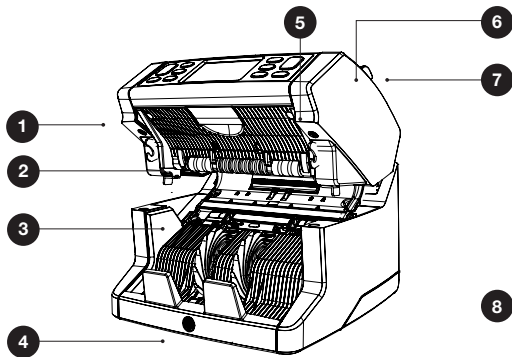

### Back

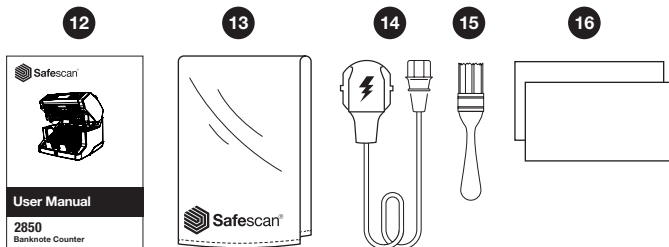
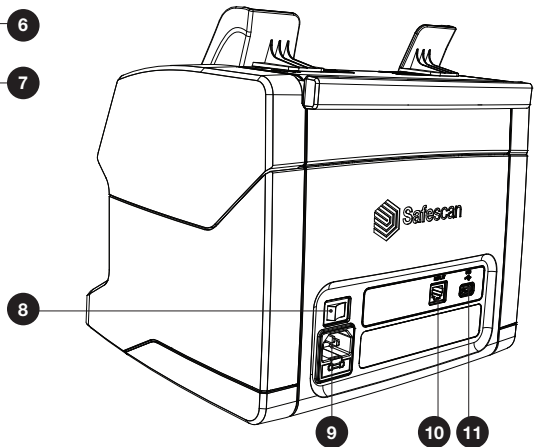

- |                                |  |
|--------------------------------|--|
| 1. Control panel               | 9. Power mains connector               |
| 2. LCD touch screen            | 10. External display connector (RJ-12) |
| 3. Lever for opening top panel | 11. Update port (USB-A)                |
| 4. Stacker                     | 12. User manual                        |
| 5. Hopper                      | 13. Dust cover                         |
| 6. Banknote guides             | 14. Power cord                         |
| 7. Feeding gab adjusting knob  | 15. Cleaning brush                     |
| 8. Power switch                | 16. Cleaning sheets (2x)               |

## Setting up your machine

1. Remove the protective foil from the LCD screen.
2. Connect the power cable to the power outlet.
3. Power on the device with the power switch.
4. The banknote counter will start. Select a language by pressing the touch screen and confirm the language selection in the next screen.
5. The device will perform a self test, during which software version number and product number will be displayed. After a successful self-test, the machine will open the count screen and is ready to use.

# Buttons & touch display

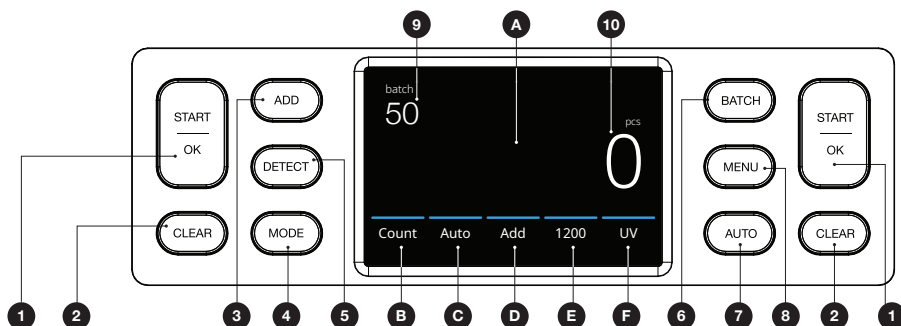

## Nr. Button Description

1.	START/OK	Start counting / Confirm selection (in MENU)
2.	CLEAR	Clear counting results
3.	ADD	Add function On/Off (ADD count results of multiple counts to the total.)
4.	MODE	Open Count mode menu
5.	DETECT	Open detection menu. (Select currency/detection type)
6.	BATCH	Open Batch menu (In BATCH menu: Loop: 100 - 50 - 25 - 20 - 10 - Off)
7.	AUTO	Automatic start counting On/Off
8.	MENU	Open the settings menu
A.		Open Quick menu
B.		Open Count mode menu
C.		Automatic start counting On/Off
D.		Add function On/Off (ADD count results of multiple counts to the total.)
E.		Open counting speed menu
F.		Open detection type menu
9.		Selected batch number
10.		Number of counted notes

# First operation

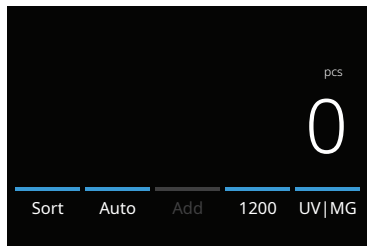

1. The device starts by default with the following settings:

- A. Detection type: **UV|MG**
- B. Counting mode: **Sort**
- C. Auto start: **ON**
- D. Add mode is Off
- E. Counting speed: 1200

2. Prevent unnecessary counting errors. Set the banknote hopper guide so that the sides of the banknotes are enclosed and therefore the banknotes are centered. Organise your banknotes in a neat stack, make sure the back of the stack is aligned straight and the notes are centered.

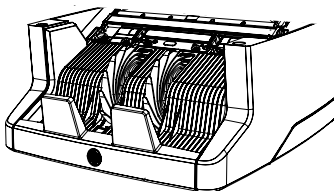

3. When the banknotes are placed on the hopper the machine will automatically start counting. Press **[AUTO]** on the screen to switch Off this function.

4. When the device detects a suspect banknote during counting, it will stop, sound an alarm and display an error message. The last counted banknote in the stacker is the suspect note. Remove this note and press **[Start/OK]** to continue counting.

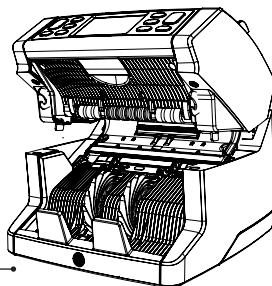

Suspected note →

5. On the screen the counting results are shown.

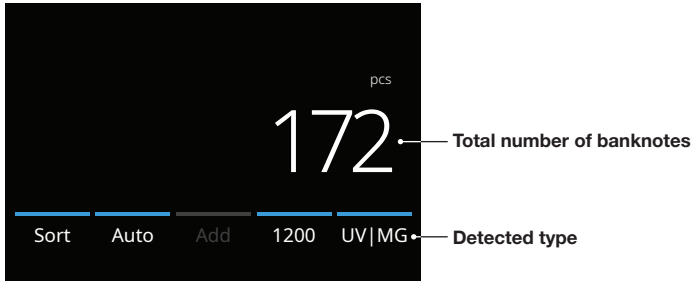

## Selecting a detection type

1. To select or change the current detection type press in the bottom right corner of the touch screen or press the **[DETECT]** button on the control panel. The detection menu opens.

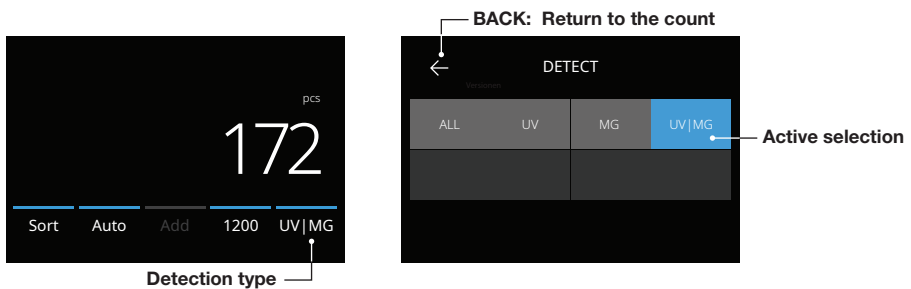

2. The detect menu contains multiple selection tiles. The active detection type has a blue coloured tile. Use **[LEFT]** & **[RIGHT]** buttons to toggle between the detect menu pages. Simply press the tile corresponding to the currency or a detection manner you require on the screen for your count.

**Note:** Selecting a detection type will determine the available count modes.

# Explanation of the available detection types

Detection	Description	Explanation of usage
<b>ALL</b>	Piece counting without any counterfeit detection.	Select a suitable detection manner depending on the currency. All currencies have <b>UV</b> features, most currencies have also <b>MG</b> features. * Plastic banknotes often have no <b>MG</b> features.
<b>UV</b>	Piece counting with UV detection.	
<b>MG</b>	Piece counting with MG detection.	
<b>UV   MG</b>	Piece counting with both UV + MG detection.	

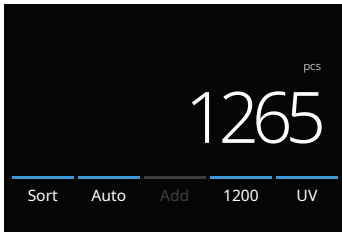

## Selecting a counting mode

1. Press the mode type in the bottom left corner or press the **[MODE]** button on the control panel. The mode menu opens.

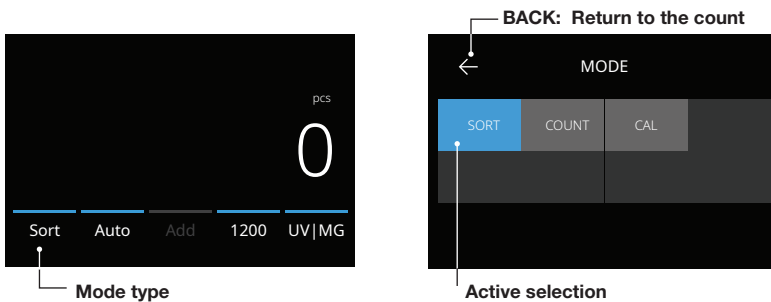

2. The mode menu contains multiple selection tiles. The active mode type has a blue coloured tile. The available mode types are determined by the active detection type. Simply press a mode type you require for your count.

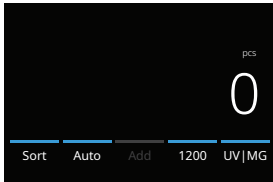
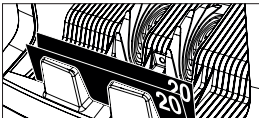
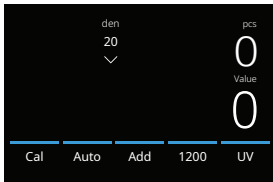
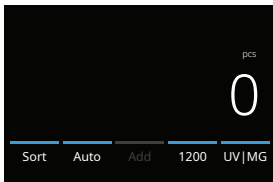

# Explanation of the available count modes

Mode	Main feature	Explanation of mode
<b>Sort</b> 	Counting number of banknotes while sorting out any different sized banknotes. 	Counting the number of banknotes sorted per size. Banknotes different in size than the first counted banknote are rejected.
<b>CAL</b> 	Counting the value and number of banknotes.	Select the value of the denominations you are planning to count. The device will automatically multiply this piece-value to the number of counted sheets to determine the value.
<b>Count</b> 	Counting the number of banknotes.	Counting the number of banknotes without checking banknote dimensions or value.

## Add function

Use the add function to add the results of multiple counts to the total. Press [ADD] in the bottom-middle of the count screen. or press the [ADD] button on the control panel. The bar above ADD will light up blue when activated.

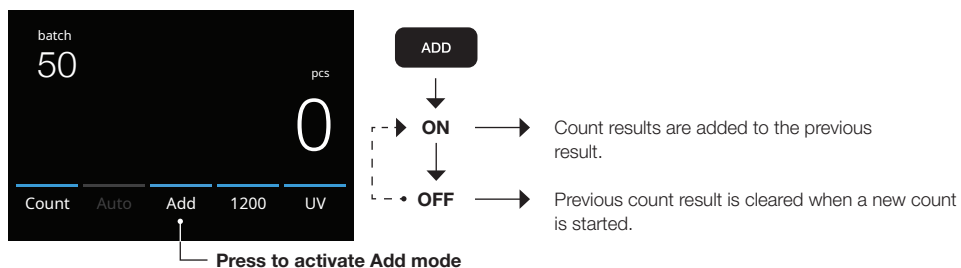

## Batch counting

The batch function is used to create stacks of an equal number of banknotes.

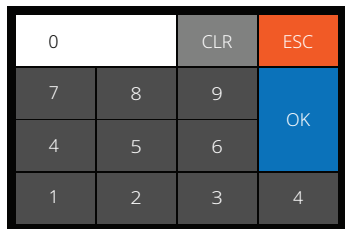

1. Type the desired batch number on the touch screen and press **[OK]** to confirm. Or repeatedly press the **[BATCH]** button to toggle between the presetted batch numbers.
  - Press **[CLR]** to clear the entry.
  - Press **[ESC]** on the touch screen to exit the batch entry screen.

Press **[BATCH]** to open the Batch entry screen. By default the batch number is set to 100.

2. In the count screen, the batch number is shown.

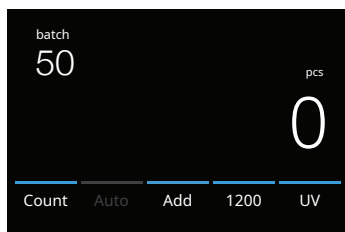

3. Place a stack of banknotes on the hopper. The device will now stop counting when the batch number has been reached.

**Note:** When the batch number is not reached the device will give 1 sound signal.

## Automatic count start

With setting 'Auto' activated the machine will automatically start count when banknotes are placed on the hopper. With Auto deactivated, the **[START]** button must be pressed to start counting.

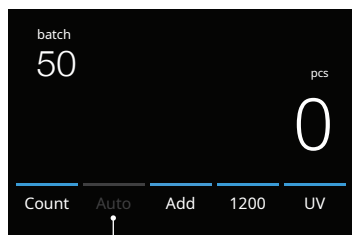

Press to activate 'Auto'matic count start

## Banknote Error messages

When the device detects a suspect banknote during counting, it will stop, sound an alarm and display an error message. The last counted banknote in the stacker is the suspect note. Remove this note and press **[Start/OK]** to continue counting. Count the banknote again to make sure if a suspected banknote is detected.

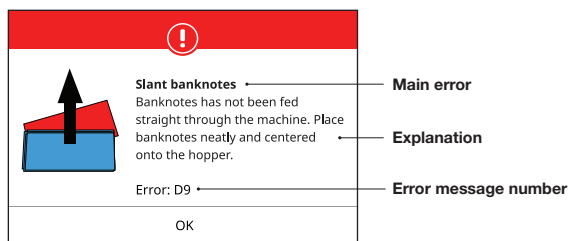

A variety of messages can be displayed. These messages can occur during start up or during counting. The error message screen shows the main error, the explanation and solution and the error message number.

## Banknote Error messages

Error	Cause	Solution(s)
<b>UV, MG</b>	<ul style="list-style-type: none"> <li>- Banknote is suspected.</li> <li>- The sensors may be dirty or blocked by dust.</li> <li>- The image or integrated UV features of banknotes may become weaker when a banknote is old, heavily used or when it has accidentally been washed.</li> </ul>	<ul style="list-style-type: none"> <li>- Count the banknote again to make sure if suspected banknote is detected.</li> <li>- Follow the cleaning procedure.</li> <li>- Check if the banknotes are dirty, damaged or worn out.</li> <li>- Make sure that the device is not in the vicinity of any magnetic fields or devices transmitting any signal since this may disrupt the integrated sensors.</li> </ul>
<b>SLANT</b>	<ul style="list-style-type: none"> <li>- The banknotes are not being fed straight through the machine.</li> </ul>	<ul style="list-style-type: none"> <li>- Ensure the banknotes are placed neatly and are inserted centred on the hopper. Use the hopper guides to center the banknotes and when counting a large stack of banknotes, guide the notes also with your hands during counting. Please refer to first operation.</li> </ul>
<b>CHAINED, DOUBLE</b>	<ul style="list-style-type: none"> <li>- More than one banknote is being fed through the machine at the same time.</li> </ul>	<ul style="list-style-type: none"> <li>- Ensure that there are no banknotes stuck, folded or glued together.</li> <li>- Check the banknote quality. If no obvious visible issues are found, count the banknote again and check if the problem persists.</li> <li>- The hopper may be set too loose. Adjust the hopper screw in clockwise direction. See chapter maintenance and servicing.</li> </ul>
<b>HALF BANKNOTE</b>	<ul style="list-style-type: none"> <li>- An incomplete, torn or half-size banknote has been detected.</li> </ul>	<ul style="list-style-type: none"> <li>- Check the banknote quality. If no obvious visible issues are found, count the banknote again and check if the problem persists.</li> </ul>
<b>WIDTH, LENGTH</b>	<ul style="list-style-type: none"> <li>- A banknote with a non-conforming size has been detected.</li> </ul>	<ul style="list-style-type: none"> <li>- Check the banknote quality. If no obvious visible issues are found, count the banknote again and check if the problem persists.</li> </ul>

# Machine error messages

Error message displayed	Solution displayed
Machine error	Please restart the device
Machine service error	Contact Safescan support: <a href="http://www.support.safescan.com">www.support.safescan.com</a>
The stacker is full	Remove all banknotes from the stacker
Top panel is open	Close the top panel
Hopper sensor blocked	Remove banknotes and clear dust from the hopper sensor.
Stacker sensors are blocked	Remove all banknotes from the stacker and clear dust from the stacker.

## Quick menu

The quick menu is a helpful tool that offers several features which are used regularly. Open the quick menu by simply pressing the middle of the touch screen once. With the quick menu opened, press a feature on the screen or press [ESC] to exit the quick menu.

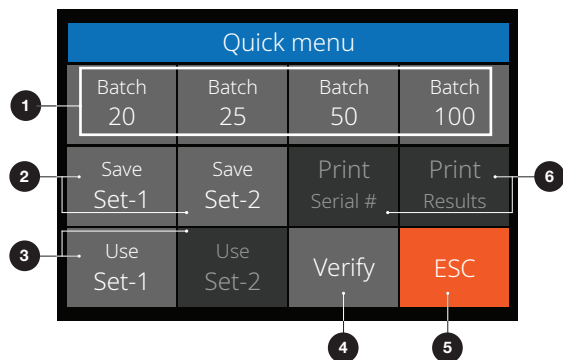

Nr.	On the screen	Description	Usage
1.	Batch 20/25/50/100	Batch presets	Instruction  <ol style="list-style-type: none"><li>1. Press the touchscreen once to open the quick menu.</li><li>2. Press a batch setting.</li><li>3. The machine will return to the count screen with the selected batch settings activated.</li></ol> <b>Note:</b> Batch presets can be adjusted in counting preferences in the menu.

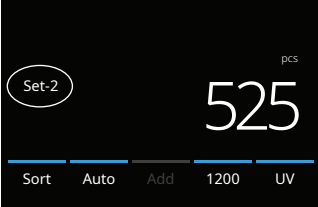
Nr.	On the screen	Description	Usage
2.	Save Set-1 & Set-2	Save counting settings as currently indicated on the machine.	<p>If certain specific counting settings are often used, it can be useful to save them on the machine. With this option, the currency, batch number, counting mode and add feature state, can be saved under Set-1 or Set-2.</p> <p>Instruction</p> <ol style="list-style-type: none"> <li>1. Set the machine to the preferred settings.</li> <li>2. Press the touchscreen once to open the quick menu.</li> <li>3. Press [Save Set-1 or Set-2].</li> <li>4. The machine saves the current settings and returns to the quick menu.</li> <li>5. Press <b>[ESC]</b> to exit the quick menu.</li> </ol> <p><b>Note:</b> Settings can always be saved. Every time the [Save Set-1 or Set-2] is pressed, the current settings will overwrite previous saved settings.</p>
3.	Use Set-1 & Set-2	Use saved counting settings.	<p>Instruction</p> <ol style="list-style-type: none"> <li>1. Press the touch screen once to open the quick menu.</li> <li>2. Press [Use Set-1 or Set-2].</li> <li>3. The count menu opens using the saved settings. On the screen, the active indication Set-1 or /Set-2 icon appears.</li> </ol> <p><b>Note:</b> Changing the settings will directly disable the Use Set-1 or Set-2. The indication icon will disappear from the screen.</p>
			
4.	Verify	Open verify count function.	<p>This function can be used to recount and check any count suspected of being wrong without adding to current batch or day totals.</p> <ol style="list-style-type: none"> <li>1. Press the touchscreen once to open the quick menu.</li> <li>2. Press <b>[Verify]</b>.</li> <li>3. The count menu opens with the current used settings. All totals of the previous count are stored in memory. On the screen, the 'Verify' indication appears.</li> <li>4. Perform 1 or more verify counts.</li> <li>5. To exit the verify mode, press the touchscreen once and press <b>[Verify]</b>.</li> <li>6. The machine will return to the saved count results of your previous counts.</li> </ol>
5.	ESC	Exit Quick Menu.	<p>Instruction</p> <ol style="list-style-type: none"> <li>1. Press <b>[ESC]</b>.</li> <li>2. The machine will return to the count screen.</li> </ol>
6.	Print / Print Serial# (Not available on this model)	Print current count results.	<b>Not applicable</b>

# Menu

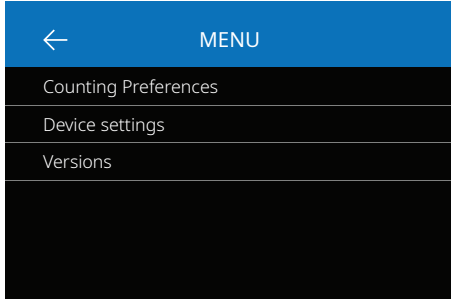

1. Press the **[MENU]** button to open the menu.
2. The menu is divided in 3 submenu's.
  - Counting preferences
  - Device settings
  - Versions
3. Press on a submenu item to open or Press [**<**] to return to the count menu.

## Working with the menu

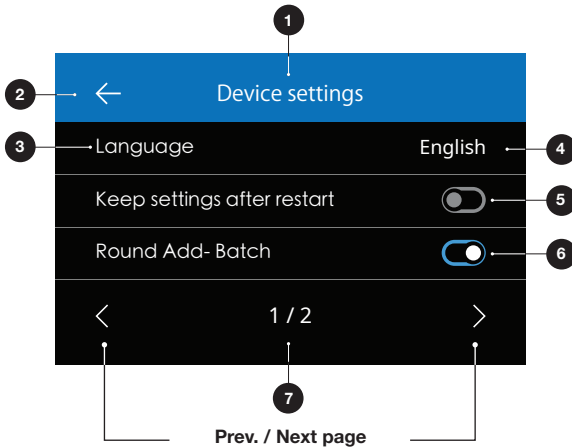

1. Current Menu/Submenu
2. Go one level back
3. Menu item
4. Item settings
5. Function switch OFF: Switch is grey
6. Function switch ON: Switch is bright white and blue.
7. Page number indication

## Menu items

Counting preference	Setting description
Button sound	Enable or disable beep sounds when a button is pressed using the On/Off switch.
Alarm sound	Enable or disable alarm sounds when an error occurs using the On/Off switch.
Batch quantities	Change preset batch numbers in quick menu.

## Menu items

Device settings	Setting description
Language	Select language of user interface.
Keep setting after restart	Enabled (On): The current user settings will be used after restarting. Disabled (Off): The device will start with automatic currency detection, count mode Mix and Batch Off.
Round Add-Batch	With both this function and Add mode activated (On), the device will only add the count result of completed batches to the total. When the batch number isn't reached, the machine will 'correct' the total to the previous multiple of the set batch amount.
CAL denominations	Select a denomination range: 1 - 1000 or 500 - 100.000
Default factory settings	Start reset procedure. After resetting, the device is set back to default factory settings. All user settings are cleared.

Versions	Setting description
Firmware version	Shows which firmware version is installed.
Software version	Shows which software version is installed.

## Maintenance & servicing

To ensure continuous reliable operation, regular cleaning of the device's internal parts and sensors is required. Dust or dirt can rub off banknotes and disturb the proper functioning of the sensors. Also in case of jam errors, it might be necessary to open the top panel to remove jammed banknotes.

**Remark:** Always power OFF the machine and pull out the power cable from the device before servicing.

## Opening the top panel and panel

Open the top panel using the opening lever under the control panel.

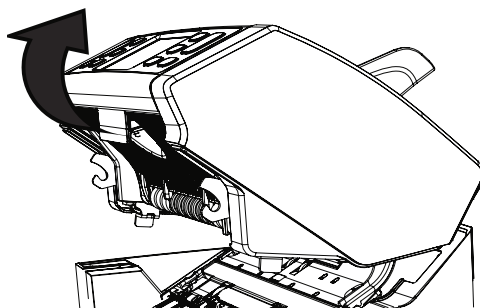

## Cleaning

Depending on the frequency of machine usage, weekly or monthly remove all dust from the sensors with a dry brush (included) or cloth. During cleaning the use of an airduster or vacuum cleaner is recommended. When using a vacuum cleaner make sure to put a soft brush attachment onto the hose. The device will automatically give maintenance advice. Please make sure to clean the device as advised.

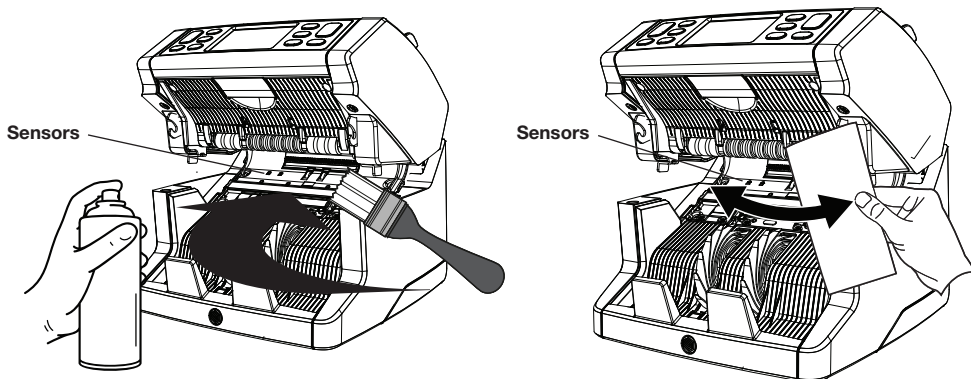

## Adjusting the feeding gap

When counting errors such as double notes, chained or slant notes occur frequently, or when banknotes are not being fed smoothly through the machine, it may be necessary to adjust the hopper feeding clearance by using the hopper adjusting knob. In the factory, the position of the hopper wheel is set optimal. However, due to the nature of some banknotes, nature of some banknotes, for example paper or polymer banknotes, adjustment may be required to ensure optimal feeding.

- When the banknotes are not being counted smoothly: increase the note thickness distance by turning the adjusting knob anti-clockwise (-).
- When counting errors such as 'double notes' or 'chained notes/double notes' occur often, decrease the note thickness distance by turning the adjusting knob clockwise (+).

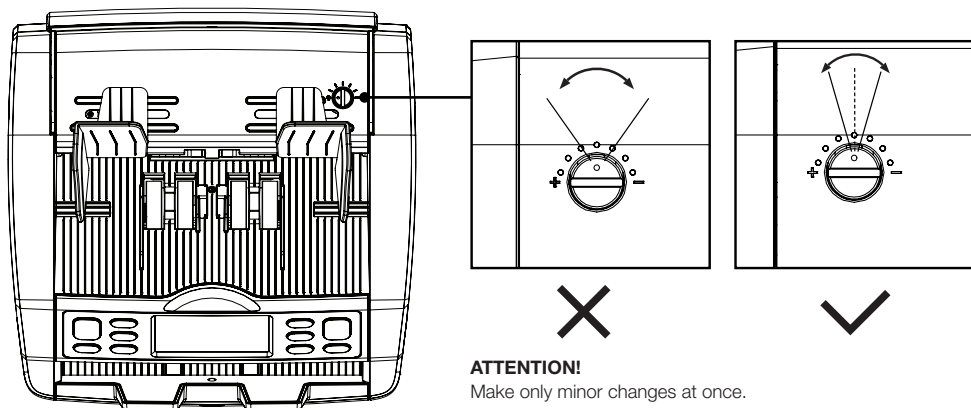

### ATTENTION!

Make only minor changes at once.  
Make changes per dot or half a dot.



## Software updates

---

To make sure your machine is up to date, please check our website regularly to see if there are updates available and needed for your device.

## Updating the device

---

1. Check the software version on your machine. The software version is displayed displayed in the Menu. Press **[MENU]** and then press 'Versions' to see the current versions.
2. Go to [www.safescan.com/downloads](http://www.safescan.com/downloads).
3. Fill in the category, product and part number. The latest software updates version will be shown.
4. Compare the version numbers and details to see if a software update is necessary.
5. If a software update is required: Download the software package and follow the included update procedure instructions.

## Technical Specifications

---

<b>Counting modes:</b>	Sort - Cal - Count
<b>Counting speed:</b>	1000, 1200 and 1500 banknotes/minute
<b>Banknote feature detection:</b>	UV, MG, MT and Thickness
<b>Banknote size range:</b>	50 x 110 mm ~ 90 x 180 mm
<b>Hopper capacity:</b>	500 banknotes
<b>Stacker capacity:</b>	220 banknotes
<b>Power:</b>	AC 220-240V / 50-60Hz.
<b>Power consumption:</b>	60W maximum
<b>Dimensions:</b>	(W x D x H) 259 x 254 x 255 mm
<b>Weight:</b>	6.4Kgs
<b>Operating Temperature:</b>	15-35 °C / 59-95 °F.

## Technical Support

---

Please visit our online support center first - go to [support.safescan.com](http://support.safescan.com) and select 'Banknote Counters'.

If you need any further assistance: our support team is available by phone during office hours (GMT +1 timezone) or by e-mail to answer any question you may have regarding the usage of your Safescan device. Visit [www.safescan.com](http://www.safescan.com) for details.

When calling or e-mailing our support center, always make sure you have the following information at hand: model number, serial number (see product sticker at the bottom of the device), software version number (shown at startup of the device) and date of purchase.

Serial number



Software version number

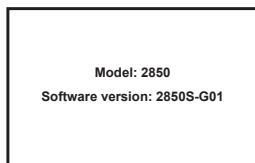

## 3 year warranty

---

Warranty procedure: [www.safescan.com](http://www.safescan.com)

 This product is in compliance with the essential requirements and other relevant provisions of the applicable European directives. The Declaration of Conformity (DoC) is available at [www.safescan.com](http://www.safescan.com)



Take the device to a recycling centre if you want to dispose of it. Never dispose of any electronic devices with household waste.



**Safescan**<sup>®</sup>

---

**Safescan B.V.**

PO Box 7067, 2701AB Zoetermeer, NL  
Designed in Europe - Made in China  
[www.safescan.com](http://www.safescan.com)

© 2021 Safescan. All rights reserved  
SAFESCAN® is a registered trademark

---

[www.safescan.com](http://www.safescan.com)

21.1